

Nominal data

Type 5214 NM

Nominal voltage	VDC	24
Nominal voltage range	VDC	12 .. 28
Speed	min ⁻¹	2750
Power input	W	4.6
Min. ambient temperature	°C	-20
Max. ambient temperature	°C	75
Air flow	m ³ /h	187
Sound power level	B	5.3
Sound pressure level	dB(A)	43

ml = Max. load · me = Max. efficiency · fa = Running at free air · cs = Customer specs · cu = Customer unit
Subject to alterations

Technical features

General description	Free air power consumption, these values may be considerably higher at the operating point.
Housing material	Fibreglass-reinforced plastic (PBT)
Impeller material	Fibreglass-reinforced plastic (PA)
Mass	0.310 kg
Dimensions	127 x 127 x 38 mm
Direction of air flow	Air exhaust over bars
Direction of rotation	Left, looking at rotor
Bearing	Ball bearings
Lifetime L10 at 40 °C	62500 h
Lifetime L10 at maximum temperature	27500 h
Connection line	Single strands AWG 22, TR 64, bared and tin-plated.
Motor protection	Protected against reverse polarity and locking.
Locked-rotor protection	With electronic blocking and overload protection
Approval	VDE, CSA, UL, CE
Option	Vario-Pro fan

5214 NM

DC axial compact fan

Product drawing

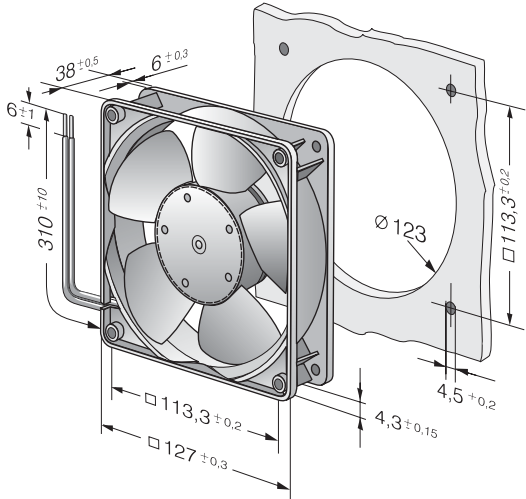

Charts: Air flow

